



**HUAWEI B818-263 LTE CPE  
V100R001  
Product Description**

**Issue**        **01**  
**Date**        **2019-09-11**

**Copyright © Huawei Technologies Co., Ltd. 2019. All rights reserved.**

No part of this document may be reproduced or transmitted in any form or by any means without prior written consent of Huawei Technologies Co., Ltd.

## **Trademarks and Permissions**



HUAWEI and other Huawei trademarks are trademarks of Huawei Technologies Co., Ltd.

LTE is a trademark of ETSI.

Wi-Fi®, the Wi-Fi CERTIFIED logo, and the Wi-Fi logo are trademarks of Wi-Fi Alliance.

All other trademarks and trade names mentioned in this document are the property of their respective holders.

## **Notice**

The purchased products, services and features are stipulated by the contract made between Huawei and the customer. All or part of the products, services and features described in this document may not be within the purchase scope or the usage scope. Unless otherwise specified in the contract, all statements, information, and recommendations in this document are provided "AS IS" without warranties, guarantees or representations of any kind, either express or implied.

The information in this document is subject to change without notice. Every effort has been made in the preparation of this document to ensure accuracy of the contents, but all statements, information, and recommendations in this document do not constitute a warranty of any kind, express or implied.

## **Huawei Technologies Co., Ltd.**

Address: Huawei Industrial Base  
Bantian, Longgang  
Shenzhen 518129  
People's Republic of China

Website: <http://consumer.huawei.com/en/>

Email: [mobile@huawei.com](mailto:mobile@huawei.com)

# About This Document

## Summary

This document provides information regarding the features, main functions and services, technical specifications, and technical references of the product.

This document includes:

Chapter	Details
1 Product Overview	Provides an overview of the product.
2 Technical Specifications	Describes the specifications of the product hardware, software, and user interface.
3 Services and Applications	Describes the main functions and applications of the product.
4 System Structure and Scenario Constraints	Describes the product system structure.
5 Technical References	Describes the standards and communication protocols of the product.
6 Packing List	Describes the devices and accessories that comprise the product package



### NOTE

The document is an invitation to offer but not an offer. It is intended to describe the general features and functions of a product. The features and functions of certain products may vary with the requirements of customers.

## History

Issue	Date	Details
01	2019-09-11	Initial official release.

## Acronyms and Abbreviations

Acronym or Abbreviation	Full Spelling
3GPP	3rd Generation Partnership Project
ACS	Auto Configuration Server
AES	Advanced Encryption Standard
ALG	Application Layer Gateway
AMR-NB	Adaptive Multi-Rate compression - Narrowband
AMR-WB	Adaptive Multi-Rate compression - Wideband
AP	Access Point
APN	Access Point Name
ARP	Address Resolution Protocol
CLAT	Customer-side Translator
CPE	Customer Premises Equipment
CS	Circuit Switched
CSFB	Circuit Switched Fallback
DBDC	Dual Band Dual Concurrent
DC-HSPA+	Dual-Carrier - High Speed Packet Access Evolution
DHCP	Dynamic Host Configuration Protocol
DL	Downlink
DMZ	Demilitarized Zone
DNS	Domain Name Server
DTMF	Dual-Tone Multi-Frequency
E-UTRA	Evolved Universal Terrestrial Radio Access Network
FDD	Frequency Division Duplex
HOTA	Huawei Firmware Over the Air
HSPA	High Speed Packet Access
HSPA+	High Speed Packet Access Evolution
IEEE	Institute of Electrical and Electronics Engineers
IP	Internet Protocol
IPSec	Internet Protocol Security
IPv4	Internet Protocol version 4

Acronym or Abbreviation	Full Spelling
IPv6	Internet Protocol version 6
ICMP	Internet Control Message Protocol
L2TP	Layer Two Tunneling Protocol
LAN	Local Area Network
LED	Light Emitting Diode
LTE	Long Term Evolution
MAC	Media Access Control
MDI	Medium Dependent Interface
MDIX	Medium Dependent Interface Crossover
MIMO	Multi-input Multi-output
MME	Mobility Management Entity
NAT	Network Address Translation
NAPT	Network Address and Port Translation
PC	Personal Computer
PCC	Primary Component Carrier
PGW	PDN Gateway
PIN	Personal Identification Number
PLAT	Provider-side Translator
PPTP	Point-to-Point Tunneling Protocol
QAM	Quadrature Amplitude Modulation
QR	Quick Response
RFC	Request For Comments
RTCP	Real-time Transport Control Protocol
RTP	Real-time Transport Protocol
SAMBA	System for Advanced Mobile Broadband Applications
SCC	Secondary Component Carrier
SCP	Service Control Point
SDRAM	Synchronous Dynamic Random Access Memory
SDP	Session Description Protocol
SGW	Serving Gateway
SIP	Session Initiation Protocol

Acronym or Abbreviation	Full Spelling
SMA	Sub-Miniature-A
SMS	Short Message
SOHO	Small Office Home Office
SSID	Service Set Identifier
TDD	Time Division Duplex
TKIP	Temporal Key Integrity Protocol
UE	User Equipment
UL	Uplink
UMTS	Universal Mobile Telecommunications System
UPnP	Universal Plug and Play
USB	Universal Serial Bus
USIM	UMTS Subscriber Identity Module
VoIP	Voice over IP
VoLTE	Voice over LTE
VPN	Virtual Private Network
WAN	Wide Area Network
WEP	Wireless Encryption Protocol
Wi-Fi	Wireless Fidelity
WMM	Wi-Fi Multimedia
WPA/WPA2-PSK	Wi-Fi Protected Access/Wi-Fi Protected Access II - Pre-Shared Key
WPA2-PSK	Wi-Fi Protected Access II - Pre-Shared Key
WPS	Wi-Fi Protected Setup

---

# Contents

---

<b>About This Document</b> .....	<b>ii</b>
<b>1 Product Overview</b> .....	<b>1</b>
<b>2 Technical Specifications</b> .....	<b>3</b>
2.1 Hardware Specifications .....	3
2.2 Antenna Specifications .....	10
2.2.1 Build-in LTE Antenna.....	10
2.2.2 Build-in Wi-Fi Antenna .....	12
2.3 Software Specifications .....	13
<b>3 Services and Applications</b> .....	<b>17</b>
3.1 Data Services .....	17
3.1.1 Accessing the Internet through a Mobile Network (LTE/UMTS).....	17
3.1.2 Accessing the Internet through an Ethernet Network .....	18
3.2 Voice Services.....	18
3.3 SMS .....	18
3.4 Security Service .....	18
3.4.1 Firewall Service .....	19
3.4.2 MAC Filtering .....	19
3.4.3 Wi-Fi Authentication.....	19
3.5 VPN Function .....	19
3.5.1 VPN Client.....	19
3.5.2 VPN Pass-Through .....	19
3.6 IP Pass-Through.....	20
3.7 IPv6 Only and IPv4v6 Dual Stack .....	20
3.7.1 IPv4v6 Dual Stack .....	20
3.7.2 IPv6 Only (CLAT) .....	20
3.8 Multi-APN .....	21
3.9 5GHz Preferred.....	21
3.10 HiLink.....	21
3.11 Customer management.....	22
3.11.1 WebUI.....	22
3.11.2 HUAWEI SmartHome APP .....	22
3.12 Operator maintenance .....	22

---

3.13 HOTA .....	22
<b>4 System Structure and Scenario Constraints.....</b>	<b>23</b>
4.1 System Architecture .....	23
4.2 Scenario Constraints .....	24
<b>5 Technical References .....</b>	<b>25</b>
5.1 Standards and Communication Protocols .....	25
5.1.1 Standards and Communication Protocols of the Product.....	25
5.1.2 Standards and Communication Protocols of the Wireless Uu Interface.....	25
<b>6 Packing List .....</b>	<b>26</b>



# 1 Product Overview

---

The HUAWEI LTE CPE B818-263 is a Long Term Evolution (LTE) wireless gateway for multiple users in household or small office environments. It enables users to access the Internet.

The B818-263 supports 3GPP Release 13 with UE downlink category 19 and uplink category 13. The supported service functions are as follows:

- Data service up to DL 1600Mbps (256QAM) and UL 150Mbps (64QAM)
- Working band: LTE: B1/3/5/7/8/20/28/32/38/40(2300~2390MHz)/41/42/43, UMTS: B1/5/8
- Voice service: CS/ VoIP (Optional) / VoLTE (Optional)
- Wi-Fi®: 802.11 b/g/n/a/ac. 2.4GHz Wi-Fi 2x2 MIMO up to 300Mbps, 5GHz Wi-Fi 2x2 MIMO up to 867Mbps. Maximum Users: 64
- 1 GE port for LAN/WAN, 1 GE port for LAN.
- Multi APN function (Optional) for Data, Voice (VoIP), TR-069 services
- Routing mode: NAT enable (Default) / IP pass-through (Optional)
- VPN client service (L2TP, PPTP)
- Customer management via WebUI or HUAWEI SmartHome APP (iOS or Android)
- Operator maintenance via TR-069 (Optional) and TR-143 (Optional)
- Huawei Firmware Over the Air (HOTA)
- 5GHz Wi-Fi preferred
- HUAWEI HiLink

**Figure 1-1** B818-263 appearance

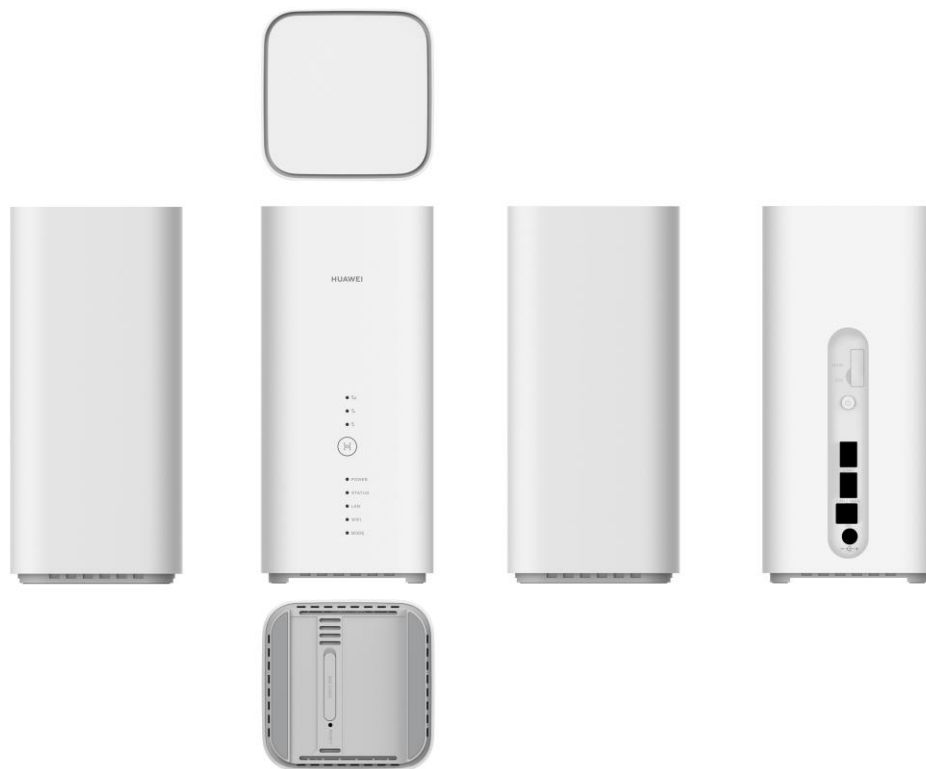

# 2 Technical Specifications

## 2.1 Hardware Specifications

**Table 2-1** Technical specifications of the B818-263 main unit

Item	Description	
Technical standard	WAN	3GPP Release 13
	LAN	IEEE 802.3/802.3u
	Wi-Fi	IEEE 802.11b/g/n/a/ac
Working band/frequency	LTE	B1/3/5/7/8/20/28/32/38/40(2300~2390MHz)/41/42/43
	UMTS	B1/5/8
	Wi-Fi	2.422 GHz~2.482 GHz, 5.170 GHz~5.330 GHz&5.490 GHz~5.710 GHz
External port	<ul style="list-style-type: none"> <li>• One power adapter port</li> <li>• One LAN/WAN port (RJ45), One LAN port (RJ45)</li> <li>• One phone port (RJ11)</li> <li>• two external LTE antenna ports (TS-9)</li> <li>• One SIM card slot (Micro-SIM)</li> </ul>	
Antennas	<ul style="list-style-type: none"> <li>• Built-in LTE/UMTS primary antenna</li> <li>• Built-in LTE/UMTS secondary antenna</li> <li>• Built-in Wi-Fi 2.4 GHz and 5 GHz antennas</li> </ul>	

Item	Description			
LED Indicators	<ul style="list-style-type: none"> <li>• Three signal strength indicators (Green) More indicators mean better reception.</li> <li>• One power indicator (Green) Off: Power off. On: Power on.</li> <li>• One Status indicator(Green) Off: Data server connection is disconnected. Flash: Firmware update. On: Data server connection is connected.</li> <li>• One LAN indicator (Green) Off: No device is connected to a LAN port. Flash: Data is being transmitted through a LAN port. On: At least one of the LAN ports is connected to a device.</li> <li>• One Wi-Fi/WPS/Hi indicator (Green) On: Wi-Fi is enabled. Flash slowly: A pairable HiLink device is detected Flash quickly: HiLink pairing is in progress/WPS connection is in progress. Off: Wi-Fi is disabled.</li> </ul> <p> <b>NOTE</b></p> <ul style="list-style-type: none"> <li>• The indicator starts to flash slowly only when B818-263 detects a new HiLink device.</li> <li>• HiLink devices include Honor routers, Honor set-up boxes, Honor handsets/ HUAWEI handsets (EMUI 5.0 and later), and more.</li> </ul> <ul style="list-style-type: none"> <li>• One MODE indicator Cyan: LTE network accessed Blue: UMTS network accessed Green: Ethernet network accessed Red: No SIM card is inserted or detected, or the SIM card has insufficient balance</li> </ul>			
Buttons	<ul style="list-style-type: none"> <li>• One Power ON/OFF switch</li> <li>• One WPS/Hi button The Wi-Fi indicator flashes slowly when the router detects a HiLink device. Press the WPS/Hi button to connect the HiLink device to the router's Wi-Fi. When the Wi-Fi indicator is steady on, press the WPS/Hi button to enable WPS.</li> <li>• One Reset button</li> </ul>			
Maximum transmit power	LTE	B1/3/5/7/8/20/28/32/38/40(2300~2390MHz)/41/42/43: 22.5 dBm+3.2/-2.2 dB		
	UMTS	B1/5/8: 22.5 dBm+3.2/-2.2 dB		
	Wi-Fi	2.4GHz	802.11b	SISO Ant0/Ant1 12 dBm(±1.5dB)

Item	Description							
		802.11g		SISO Ant0/Ant1 14 dBm( $\pm 1.5$ dB) MIMO 16 dBm( $\pm 1.5$ dB)				
		802.11n		SISO Ant0/Ant1 14 dBm( $\pm 1.5$ dB) MIMO 16 dBm( $\pm 1.5$ dB)				
	5GHz	5G LF ( $\pm 2$ dB) *Some edge band power is reduced		5G MF ( $\pm 2$ dB) *Some edge band power is reduced		5G HF ( $\pm 2$ dB) *Some edge band power is reduced		
		Ant0	Ant1	Ant0	Ant1	Ant0	Ant1	
	11a 6M	15	15	15	15	20	20	
	11a 54M	15	15	15	15	17	17	
	11n 20M MCS0	15	15	15	15	20	20	
	11n 20M MCS7	15	15	15	15	17	17	
	11n 40M MCS0	17	17	17	17	20	20	
	11n 40M MCS7	17	17	17	17	17	17	
	11ac 20M MCS0	15	15	15	15	20	20	
	11ac 20M MCS8	15	15	15	15	16	16	
	11ac 40M MCS0	17	17	17	17	20	20	
	11ac 40M MCS9	16	16	16	16	16	16	
	11ac 80M MCS0	17	17	17	17	20	20	
	11ac 80M MCS9	16	16	16	16	16	16	
Receiving sensitivity	LTE	Band	1.4MHz (dBm)	3MHz (dBm)	5MHz (dBm)	10MHz (dBm)	15MHz (dBm)	20MHz (dBm)
		B1	/	/	-100.2	-97.8	-96	-94.9
		B3	-105.6	-102.3	-100.6	-98.5	-96.9	-95.9
		B5	-107.2	-103.8	-101.6	-98.9	/	/
		B7	/	/	-97.5	-95.3	-93.6	-92.2
		B8	-106.5	-102.7	-100.8	-98.9	/	/

Item	Description							
	B20	/	/	-101.3	-99	-96.9	-95.8	
	B28	/	-102.5	-100.6	-98.3	-96.7	-95.5	
	B32	/	/	-101.9	-99.3	-97.6	-96.5	
	B38	/	/	-98.3	-96.3	-94.7	-93.3	
	B40	/	/	-99.1	-96.5	-94.9	-93.6	
	B41	/	/	-97.5	-95.5	-93.9	-92.1	
	B42	/	/	-100.2	-97.5	-95.7	-94.4	
	B43	/	/	-100.1	-97.7	-95.9	-95.1	
	UMTS	<ul style="list-style-type: none"> <li>• B1: -109.4 dBm</li> <li>• B5: -111.4 dBm</li> <li>• B8: -111.4 dBm</li> </ul>						
	Wi-Fi	<ul style="list-style-type: none"> <li>• 2.4G 802.11b: -88 dBm</li> <li>• 2.4G 802.11g: -75 dBm</li> <li>• 2.4G 802.11n 20M: -73 dBm</li> <li>• 2.4G 802.11n 40M: -70.5 dBm</li> <li>• 5G 802.11a: -76.5 dBm</li> <li>• 5G 802.11n 20M: -74.5 dBm</li> <li>• 5G 802.11n 40M: -71.5 dBm</li> <li>• 5G 802.11ac 20M: -70.5 dBm</li> <li>• 5G 802.11ac 40M: -65.5 dBm</li> <li>• 5G 802.11ac 80M: -62 dBm</li> </ul>						
Power consumption	< 24 W							
AC/DC power supply	<ul style="list-style-type: none"> <li>• AC (input): 100V-240V 50Hz/60Hz</li> <li>• DC (output): 12V/2A</li> </ul>							
Dimensions (Maximum)	103 mm (Length) x 103 mm (Width) x 225 mm (Height)							
Weight	About 614g (excluding the power adapter)							
Temperature	<ul style="list-style-type: none"> <li>• Working temperature: 0 ℃ to 40 ℃</li> <li>• Storage temperature: -20 ℃ to +70 ℃</li> </ul>							
Humidity	5% – 95% (non-condensing)							

Item	Description
Certification/Compliance	CE certification RoHS REACH WEEE Wi-Fi certification ErP

**Table 2-2** Frequency band combination of the B818-263

Item	Description	
	LTE	2CA(DL)
Frequency band combination		DL
		MIMO
	CA_3C	4+4/2+2
	CA_7C	4+4/2+2
	CA_38C	4+4/2+2
	CA_40C	4+4/2+2
	CA_41C	4+4/2+2
	CA_42C	4+4/2+2
	CA_43C	4+4/2+2
	CA_3A-3A	4+2/2+2
	CA_7A-7A	4+2/2+2
	CA_41A-41A	4+4/4+2/2+2/2+4
	CA_42A-42A	2+2
	CA_1A-3A	4+4/4+2/2+2/2+4
	CA_1A-5A	4+2/2+2
	CA_1A-7A	4+4/4+2/2+2/2+4
	CA_1A-8A	4+2/2+2
	CA_1A-20A	4+2/2+2
	CA_1A-28A(B28 SCC)	4+2/2+2
	CA_1A-38A	4+2/2+2/2+4
	CA_1A-40A	4+2/2+2/2+4
	CA_1A-41A	4+2/2+2/2+4
	CA_1A-42A	4+4/4+2/2+2/2+4
	CA_3A-5A	4+2/2+2
	CA_3A-7A	4+4/4+2/2+2/2+4
	CA_3A-8A(B8 SCC)	4+2
	CA_3A-20A	4+2
	CA_3A-28A	4+2
	CA_3A-32A	4+2
	CA_3A-38A	4+4
CA_3A-40A	4+4	
CA_3A-42A	4+4	
CA_7A-8A(B8 SCC)	4+2	
CA_7A-20A	4+2	

		CA_7A-28A	4+2
		CA_7A-32A	4+2
		CA_7A-40A	4+4
		CA_8A-32A	2+2
		CA_20A-32A	2+2
		CA_20A-38A	2+4
		3CA(DL)	
		<b>DL</b>	<b>MIMO</b>
		CA_40D	4+4+4
		CA_41D	4+4+4
		CA_42D	4+4+4
		CA_1A-3C	4+4+4
		CA_1A-3A-5A	4+4+2
		CA_1A-3A-7A	4+4+4
		CA_1A-3A-8A(B8 SCC)	4+4+2
		CA_1A-3A-20A	4+4+2
		CA_1A-3A-28A(B28 SCC)	4+4+2
		CA_1A-3A-32A	4+4+2
		CA_1A-3A-38A	4+4+2/2+4+4
		CA_1A-3A-40A	4+4+2/2+4+4
		CA_1A-3A-41A	4+4+2/2+4+4
		CA_1A-7C	4+4+4
		CA_1A-7A-7A	4+4+2
		CA_1A-7A-20A	4+4+2
		CA_1A-7A-28A (B28 SCC)	4+4+2
		CA_1A-7A-32A	4+4+2
		CA_1A-20A-32A	4+2+2
		CA_1A-20A-38A	4+2+2/2+2+4
		CA_1A-38C	4+2+2/2+4+4
		CA_1A-40C	4+2+2/2+4+4
		CA_1A-42C	4+4+4
		CA_3A-7C	4+4+4
		CA_3A-40C	4+4+4
		CA_3A-42C	4+4+4
		CA_3C-5A	4+4+2
		CA_3C-7A	4+4+4
		CA_3C-8A (B8 SCC)	4+4+2
		CA_3C-20A	4+4+2
		CA_3C-28A	4+4+2
		CA_3C-32A	4+4+2
		CA_3A-3A-20A	2+2+2
		CA_3A-7A-7A	4+4+2
		CA_3A-7A-8A (B8 SCC)	4+4+2
		CA_3A-7A-20A	4+4+2
		CA_3A-7A-28A	4+4+2
		CA_3A-7A-32A	4+4+2
		CA_3A-7A-38A	4+4+4
		CA_3A-7A-40A	4+4+4
		CA_3A-8A-38A	4+2+4
		CA_3A-20A-32A	4+2+2
		CA_7A-40C	4+4+4



		CA_7C-20A	4+4+2
		CA_7C-28A	4+4+2
		CA_7A-20A-32A	4+2+2
		CA_7A-20A-38A	4+2+4
		CA_20A-38C	2+4+4
		CA_28A-40C	2+4+4
		4CA(DL)	
		<b>DL</b>	<b>MIMO</b>
		CA_1A-3A-7C	4+4+4+4
		CA_1A-3A-40C	4+4+2+2/2+4+4
		CA_1A-3C-5A	4+4+4+2
		CA_1A-3C-7A	4+4+4+4
		CA_1A-3C-8A (B8 SCC)	4+4+4+2
		CA_1A-3C-20A	4+4+4+2
		CA_1A-3C-28A (B28 SCC)	4+4+4+2
		CA_1A-3A-7A-8A (B8 SCC)	4+4+4+2
		CA_1A-3A-7A-20A	4+4+4+2
		CA_1A-3A-7A-28A (B28 SCC)	2+4+4+2
		CA_1A-3A-7A-32A	4+4+4+2
		CA_1A-3A-8A-38A	4+4+2+2/2+4+2+4
		CA_1A-7A-38C	2+4+2+2
		CA_1A-7A-40C	4+4+2+2/2+2+4+4
		CA_1A-7C-28A (B28 SCC)	4+4+4+2
		CA_1A-20A-38C	4+2+2+2/2+2+4+4
		CA_3C-7C	4+4+4+4
		CA_3C-7A-20A	4+4+4+2
		CA_3C-7A-28A	4+4+4+2
		CA_3C-7A-32A	4+4+4+2
		CA_3A-7A-20A-32A	4+4+2+2
		CA_3A-7A-40C	4+4+4+4
		CA_3A-7C-20A	4+4+4+2
		CA_3A-7C-28A	4+4+4+2
		CA_3A-28A-40C	2+2+4+4
		CA_3A-40D	4+4+4+4
		CA_7A-20A-38C	4+2+4+4
		CA_7A-28A-40C	4+2+4+4
		CA_7A-40D	4+4+4+4
		CA_28A-40D	2+4+4+4
		CA_40E	4+4+4+4
		CA_42C-42C	2+2+2+2
		5CA(DL)	
		<b>DL</b>	<b>MIMO</b>
		CA_1A-3C-7C	4+2+2+4+4

		CA_1A-3A-7C-28A (B28 SCC)	2+4+4+4+2
		CA_1A-3A-7A-20A-32A	4+4+4+2+2
		CA_1A-3A-7A-40C	2+4+2+4+4
		CA_1A-3A-28A-40C	2+4+2+4+4
		CA_1A-7A-28A-40C	2+2+2+4+4/2+ 4+2+2+2
		CA_3C-7D	2+2+4+4+4
		CA_3C-7C-28A	2+2+4+4+2
		CA_3A-7A-28A-40C	4+2+2+4+4
		CA_3A-28A-40D	2+2+4+4+4
		2CA(UL)	
		UL	MIMO
		CA_3C	/
		CA_7C	/
		CA_38C	/
		CA_40C	/
		CA_41C	/
		CA_42C	/
		CA_1A-3A	/
		CA_1A-7A	/
		CA_1A-20A	/
		CA_3A-7A	/
		CA_3A-8A	/
		CA_3A-28A	/
		CA_3A-20A	/
		CA_7A-28A	/
		CA_7A-20A	/

Note:

The above CA combination is a complete set of product support capabilities that operators can customize within the complete set of capabilities.

## 2.2 Antenna Specifications

### 2.2.1 Build-in LTE Antenna

Table 2-3 LTE antenna specifications

Item	Description
Frequency	LTE <ul style="list-style-type: none"> <li>• B1: UL 1920–1980 MHz DL 2110–2170 MHz</li> <li>• B3: UL 1710–1785 MHz DL 1805–1880 MHz</li> <li>• B5: UL 824–849 MHz DL 869–894 MHz</li> <li>• B7: UL 2500–2570 MHz DL 2620–2690 MHz</li> <li>• B8: UL 880–915 MHz DL 925–960 MHz</li> <li>• B20: UL 832–862 MHz DL 791–821 MHz</li> <li>• B28: UL 703–748 MHz DL 758–803 MHz</li> </ul>

Item	Description
	<ul style="list-style-type: none"> <li>• B32: / DL 1452–1496 MHz</li> <li>• B38: UL 2570–2620MHz DL 2570–2620 MHz</li> <li>• B40: UL 2300–2390 MHz DL 2300–2390MHz</li> <li>• B41: UL 2496–2690 MHz DL 2496–2690 MHz</li> <li>• B42: UL 3400–3600 MHz DL 3400–3600 MHz</li> <li>• B43: UL 3600–3800 MHz DL 3600–3800 MHz</li> </ul> <p>UMTS</p> <ul style="list-style-type: none"> <li>• B1: UL 1920–1980 MHz DL 2110–2170 MHz</li> <li>• B5: UL 824–849 MHz DL 869–894 MHz</li> <li>• B8: UL 880–915 MHz DL 925–960 MHz</li> </ul>
Input impedance	50 Ω
Standing wave ratio	< 2.5
Main antenna efficiency	<p>LTE</p> <ul style="list-style-type: none"> <li>• B1: -2 dB</li> <li>• B3: -2.4 dB</li> <li>• B5: -2 dB</li> <li>• B7: -2.2 dB</li> <li>• B8: -2.5 dB</li> <li>• B20: -2.5 dB</li> <li>• B28: -2.5 dB</li> <li>• B38: -2.2 dB</li> <li>• B40: -2 dB</li> <li>• B41: -2.5 dB</li> <li>• B42: -3 dB</li> <li>• B43: -3 dB</li> </ul> <p>UMTS</p> <ul style="list-style-type: none"> <li>• B1: -2 dB</li> <li>• B5: -2 dB</li> <li>• B8: -2.5 dB</li> </ul>
Diversity antenna efficiency	<p>LTE</p> <ul style="list-style-type: none"> <li>• B1: -2 dB</li> <li>• B3: -2.5dB</li> <li>• B5: -2.5dB</li> <li>• B7: -2.7dB</li> <li>• B8: -3 dB</li> <li>• B20: -3 dB</li> <li>• B28: -2.7 dB</li> <li>• B32: -3.2 dB</li> <li>• B38: -2.5 dB</li> </ul>

Item	Description
	<ul style="list-style-type: none"> <li>• B40: -2.5 dB</li> <li>• B41: -2.8 dB</li> <li>• B42: -3.2 dB</li> <li>• B43: -3.2 dB</li> </ul> UMTS <ul style="list-style-type: none"> <li>• B1: -2 dB</li> <li>• B5: -2.5 dB</li> <li>• B8: -3 dB</li> </ul>
Main antenna gain	LTE <ul style="list-style-type: none"> <li>• B3/5/7/8/38/40/41: 2~3 dBi</li> <li>• B1/20/28/42/43: 3~4 dBi</li> </ul> UMTS <ul style="list-style-type: none"> <li>• B5/8: 2~3 dBi</li> <li>• B1: 3~4 dBi</li> </ul>
Diversity antenna gain	LTE <ul style="list-style-type: none"> <li>• B20/28: 1~2 dBi</li> <li>• B3/5/8/42: 2~3 dBi</li> <li>• B1/7/38/40/41/43: 3~4 dBi</li> </ul> UMTS <ul style="list-style-type: none"> <li>• B5/8: 2~3 dBi</li> <li>• B1: 3~4 dBi</li> </ul>
TX/RX	1T4R (Not all frequency bands are supported)
Polarization	Linear polarization

## 2.2.2 Build-in Wi-Fi Antenna

**Table 2-4** Wi-Fi 2.4 GHz antenna specifications

Item	Description
Frequency	2.422 GHz-2.482 GHz (Channel 5 – Channel 13)
Input impedance	50 $\Omega$
Standing wave ratio	< 2
Efficiency	-2.2 dB
Gain	$\geq 1$ dBi
Polarization	Linear polarization

**Table 2-5** Wi-Fi 5 GHz antenna specifications

Item	Description
Frequency	5.170 GHz-5.330 GHz&5.490 GHz-5.710 GHz
Input impedance	50 Ω
Standing wave ratio	< 2
Efficiency	-3 dB
Gain	≥1 dBi
Polarization	Linear polarization

## 2.3 Software Specifications

**Table 2-6** Software specifications

Item	Description	
LTE features	DL 4x4 MIMO+4CC/5CC	
	DL 256QAM, UL 64QAM	
Mobile network	APN management APN auto adapter	
Gateway	Router	<ul style="list-style-type: none"> <li>Supports the default route: 0.0.0.0</li> <li>Supports manual configuration of LAN IP addresses</li> <li>Supports Address Resolution Protocol (ARP)</li> </ul>
	DHCP server	<ul style="list-style-type: none"> <li>The DHCP server can be enabled or disabled</li> <li>The address pool of the DHCP server can be configured</li> <li>The lease can be configured</li> <li>The DNS relay under the DHCP server can be enabled</li> </ul>
	NAT	<ul style="list-style-type: none"> <li>Supports NAT and NAPT (compliant with RFC2663, RFC3022, and RFC3027)</li> <li>Supports cone NAT</li> </ul>
	ARP	
	ICMP	

Item	Description	
	IPv4v6 dual stack IPv6 only (Optional , CLAT for LAN side IPv4 device access Internet) IPv4 only (Optional)  <b>NOTE</b> When the CLAT function is enabled, the IPv4 device Internet access service cannot reach the maximum throughput. Under IPv6 only, NAT-base service (such as port forwarding and port triggering) is not available	
VPN client	<ul style="list-style-type: none"> <li>• Support L2TP VPN client</li> <li>• Support PPTP VPN client</li> </ul>	
SMS	<ul style="list-style-type: none"> <li>• Writing/sending/receiving</li> <li>• Writing/sending/receiving extra-long messages</li> </ul>	
Data service	<ul style="list-style-type: none"> <li>• LTE FDD: DL 1600Mbps, UL 150Mbps</li> <li>• DC-HSPA+: DL 42 Mbps, UL 5.76 Mbps</li> <li>• HSPA+: DL 21 Mbps (64QAM), UL 5.76 Mbps</li> <li>• HSPA: DL 14.4 Mbps, UL 5.76 Mbps</li> <li>• WCDMA PS: DL 384 Kbps, UL 384 Kbps</li> </ul> Wi-Fi 802.11b/g/n/a/ac Supports multi APNs (Optional, one for data, one for voice, and one for TR-069)	
Voice	VoIP (Optional)	Supports G.711a/G.711u/G.726 (-24/-32)/G.722/G.729 codec Supports SIP (RFC3261) Supports SDP (RFC2327) Supports RTP/RTCP (RFC1889/RFC1890/RFC3550) Supports in-band/SIP info/RFC2833 DTMF Supports the following phone features: <ul style="list-style-type: none"> <li>• Caller ID generation</li> <li>• Call waiting</li> <li>• Call forwarding (unconditional, busy, and no answer forwarding)</li> <li>• Call hold</li> <li>• Three-way conference</li> </ul>
	CS	Supports CS voice communication over UMTS networks Supports circuit switched fallback (CSFB)

Item	Description	
		Supports the following phone features: <ul style="list-style-type: none"> <li>• Caller ID generation</li> <li>• Call waiting</li> <li>• Call forwarding (unconditional, busy, and no answer forwarding)</li> <li>• Call hold</li> <li>• Three-way conference</li> <li>• Originating Identification Presentation/Restriction</li> <li>• Outgoing Communication Barring</li> </ul>
	VoLTE (Optional)	<ul style="list-style-type: none"> <li>• Supports AMR-NB codec</li> <li>• Supports AMR-WB codec</li> </ul>
		Supports SRVCC to UMTS
		Supports in-band/out-band (RFC2833) DTMF
		Supports the following phone features: <ul style="list-style-type: none"> <li>• Caller ID generation</li> <li>• Call waiting</li> <li>• Call forwarding (unconditional, busy, and no answer forwarding)</li> <li>• Call hold</li> <li>• Three-way conference</li> <li>• Originating Identification Presentation/Restriction</li> <li>• Outgoing Communication Barring</li> </ul>
Firewall setup	<ul style="list-style-type: none"> <li>• Firewall enable/disable</li> <li>• URL filtering</li> <li>• LAN IP filtering</li> <li>• Port forwarding (Virtual server)</li> <li>• Port triggering (Special Application)</li> <li>• DMZ service</li> <li>• UPnP service</li> <li>• ALG settings</li> </ul>	
LAN	<ul style="list-style-type: none"> <li>• 10/100/1000 Mbps auto-negotiation</li> <li>• MDI/MDIX auto-sensing</li> <li>• IEEE 802.3/802.3u-compatible</li> </ul>	
Wi-Fi	Broadcasts and hides service set identifiers (SSIDs)	
	Complies with IEEE 802.11b/g/n/a/ac	
	WPS	
	WMM	

Item	Description	
	Encryption	WEP, AES, and TKIP + AES
	Security mode	<ul style="list-style-type: none"> <li>• Open</li> <li>• WPA2-PSK</li> <li>• WPA/WPA2-PSK</li> <li>• WEP</li> </ul>
	MAC address authentication	<ul style="list-style-type: none"> <li>• Supports the MAC address authentication whitelist</li> <li>• Supports the MAC address authentication blacklist</li> <li>• Supports a maximum of 10 MAC address entries</li> </ul>
	STA	<ul style="list-style-type: none"> <li>• Supports inquiry of STA status</li> <li>• Supports a maximum of 64 connected stations</li> </ul>
Operator maintenance (Optional)	<ul style="list-style-type: none"> <li>• Supports TR-069 Amendment III</li> <li>• Supports TR-098 Amendment II</li> <li>• Supports TR-143 Amendment I</li> <li>• Supports TR-104 Amendment I (if VoIP is available)</li> </ul>	
USIM	PIN management and USIM card authentication	
NTP	Supports daylight saving time (DST) (Optional)	
HUAWEI SmartHome APP	<ul style="list-style-type: none"> <li>• View data traffic usage and SMS</li> <li>• Manage connected devices</li> <li>• Change CPE's SSID and password</li> </ul>	
System requirements	Web browser	<ul style="list-style-type: none"> <li>• Microsoft Internet Explorer 9.0 and Microsoft Edge with latest updates</li> <li>• Firefox 49.0 with latest updates</li> <li>• All major versions of Chrome in the last year (53.0 with latest updates)</li> <li>• Safari 10.0 with latest updates (Mac OS)</li> </ul>
	Your computer's hardware system should meet or exceed the recommended system requirements for the installed OS version	



# 3 Services and Applications

## 3.1 Data Services

The B818-263 can access the Internet through mobile networks and Ethernet networks. By connecting to the B818-263 using Wi-Fi or a network cable, users can obtain access to high-speed Internet services and establish a local area network (LAN).

### 3.1.1 Accessing the Internet through a Mobile Network (LTE/UMTS)

The B818-263 can access the Internet through mobile networks.

**Figure 3-1** Accessing the Internet through a mobile network

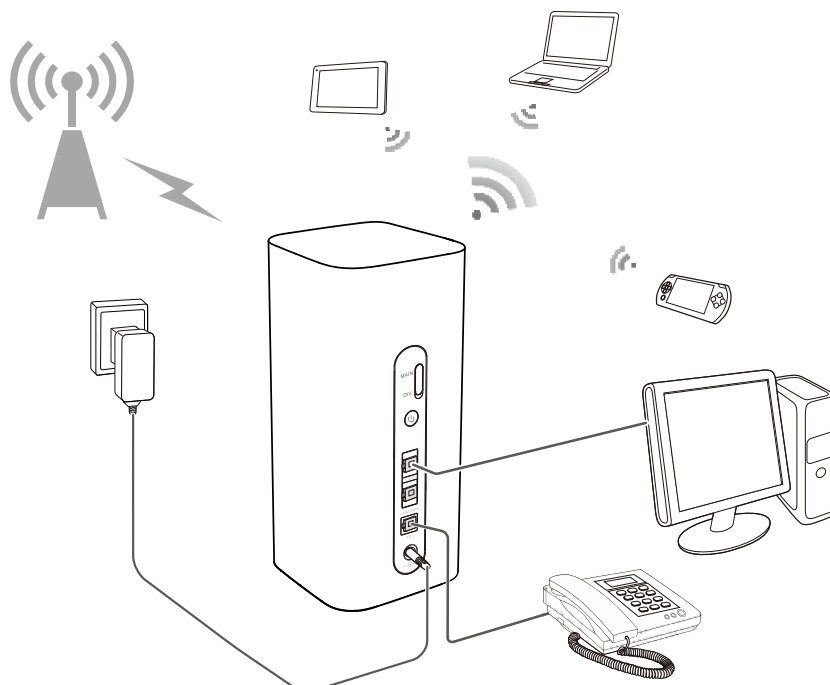

## 3.1.2 Accessing the Internet through an Ethernet Network

The B818-263's LAN/WAN port can be connected to a wall-mounted Ethernet port using a network cable.

**Figure 3-2** Accessing the Internet through an Ethernet network

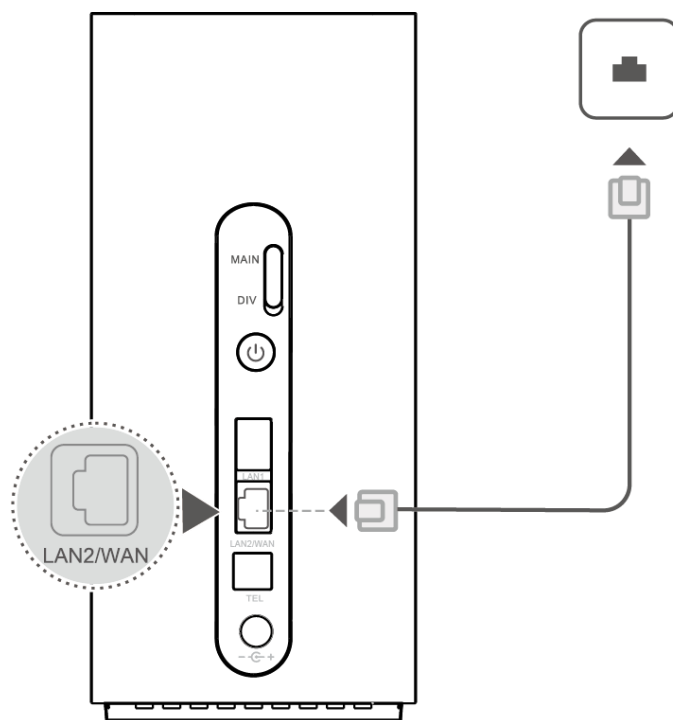

## 3.2 Voice Services

The B818-263 provides one telephone port that can be connected to telephones for calling.

## 3.3 SMS

The B818-263 supports message writing/sending/receiving and group sending (up to 50 contacts at a time).

## 3.4 Security Service

The B818-263 supports comprehensive and robust security services. It provides a firewall function and PIN protection mechanisms. These features allow users to connect their computers to the Internet and simultaneously protect their computers against security threats from the Internet.

## 3.4.1 Firewall Service

The B818-263 supports the enabling or disabling of a firewall on the network connection, which protects the device and network from attacks by hackers on the Internet and controls access to the Internet.

## 3.4.2 MAC Filtering

The B818-263 supports configuration of the Media Access Control (MAC) address to restrict network access.

## 3.4.3 Wi-Fi Authentication

The gateway supports the following user authentication protocols for Wi-Fi:

- No encryption
- WEP, WPA2-PSK (AES), WPA/WPA2-PSK (TKIP/AES).

## 3.5 VPN Function

### 3.5.1 VPN Client

VPN tunneling involves establishing and maintaining a logical network connection (that may contain intermediate hops). On this connection, packets constructed in a specific VPN protocol format are first encapsulated within some other base or carrier protocol, then transmitted between the VPN client and server, and finally decapsulated on the receiving side.

The B818-263 supports L2TP and PPTP tunneling protocols.

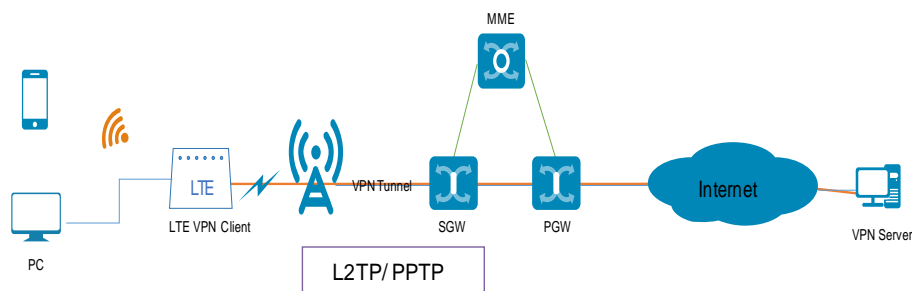

### 3.5.2 VPN Pass-Through

The B818-263 supports L2TP/PPTP/IPsec VPN pass-through for the LAN side device. The LAN side device can create a VPN tunnel to the VPN server.

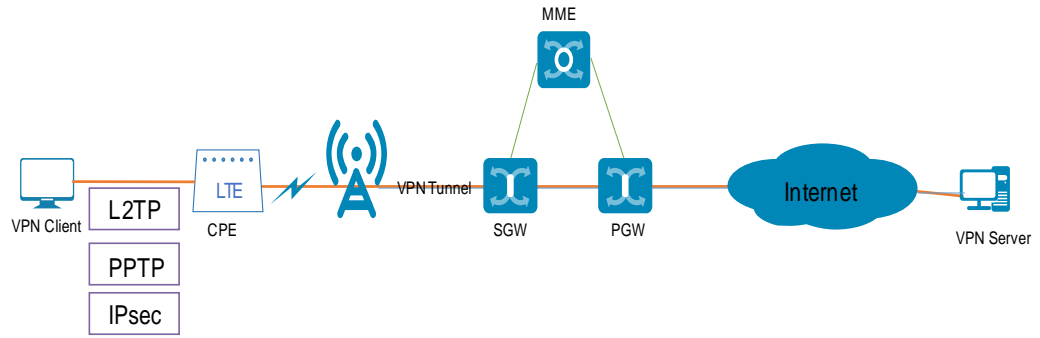

### 3.6 IP Pass-Through

The LTE CPE obtains the WAN IP address and passes it through to the PC (Case 1) or Router (Case 2), and then the PC (Case 1) or Router (Case 2) can directly use the WAN IP address.

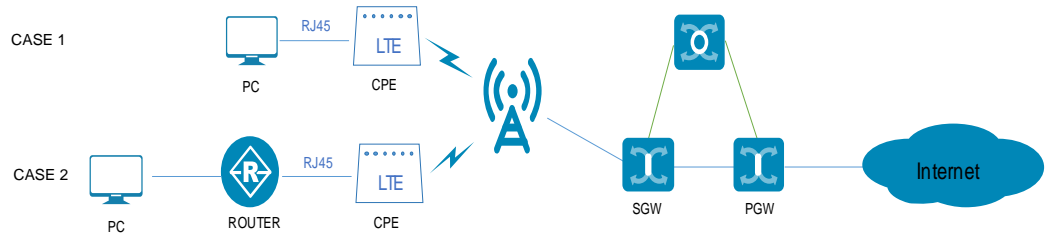

### 3.7 IPv6 Only and IPv4v6 Dual Stack

#### 3.7.1 IPv4v6 Dual Stack

CPE provides dual stack function.

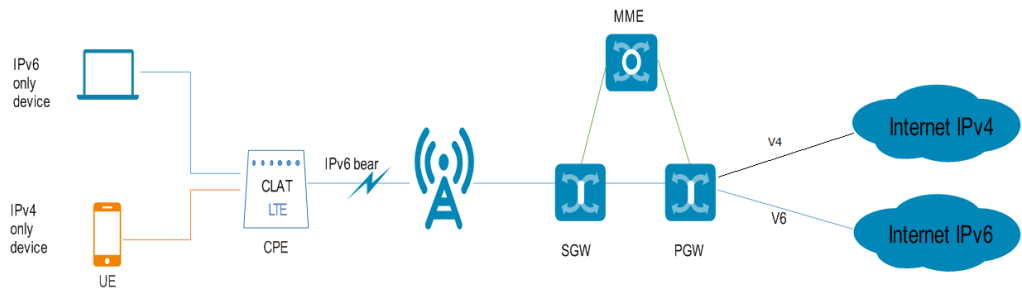

#### 3.7.2 IPv6 Only (CLAT)

The LTE CPE supports IPv6 only with the transition solution CLAT for IPv4 device.

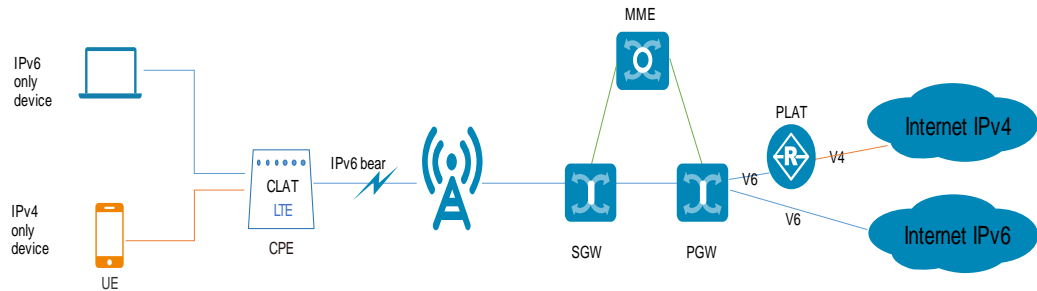

**NOTE**

When the IPv6 only (CLAT) function is enabled, NAT-based functions (like DMZ/Port Forwarding/Port tigger) cannot be used.

When an IPv4 device accesses the Internet, the performance is degraded because packets need to be packetized and unpacked. However, IPv6 devices are not affected.

### 3.8 Multi-APN

The B818-263 supports the establishment and maintenance of three APNs. These three APN connections isolate data, voice, and remote management services on an operator's network.

The B818-263 supports an independent APN for CPE internal/VoIP/TR-069.

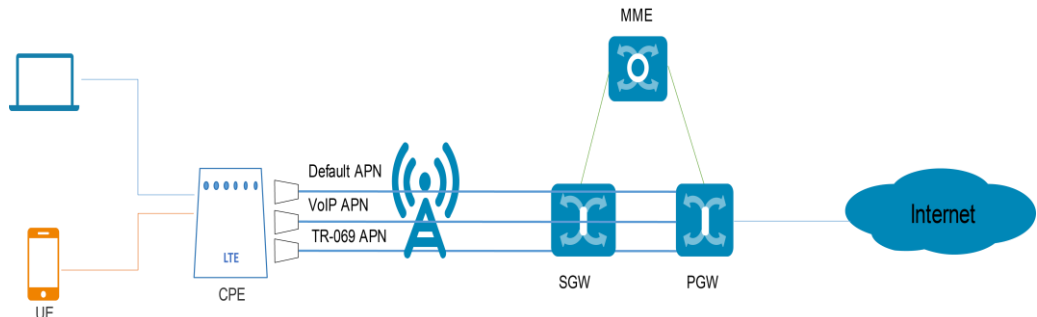

### 3.9 5GHz Preferred

Priority usage of 5 GHz Wi-Fi band over 2.4 GHz band when signal strength is equal to increase connection speeds.

### 3.10 HiLink

- Supports HiLink routers to connect to B818-263 through the WPS/Hi button to create an expanded network.
- Supports quick connection between a HiLink device (such as Honor set-up boxes, Honor handsets and HUAWEI handsets running on EMUI 5.0 and later) and B818-263 through the WPS/Hi button.

## 3.11 Customer management

### 3.11.1 WebUI

The B818-263 supports local configuration through the Web UI. You can perform device management and network configuration to ensure normal and stable performance.

### 3.11.2 HUAWEI SmartHome APP

Scan the QR code (can be found in the Quick Start Guide and Web UI) to download the HUAWEI SmartHome APP and configure the router from your phone.

## 3.12 Operator maintenance

The B818-263 supports Operator maintenance through the TR-069. Operator remote manages the CPE software update/parameters configuration via TR-069.

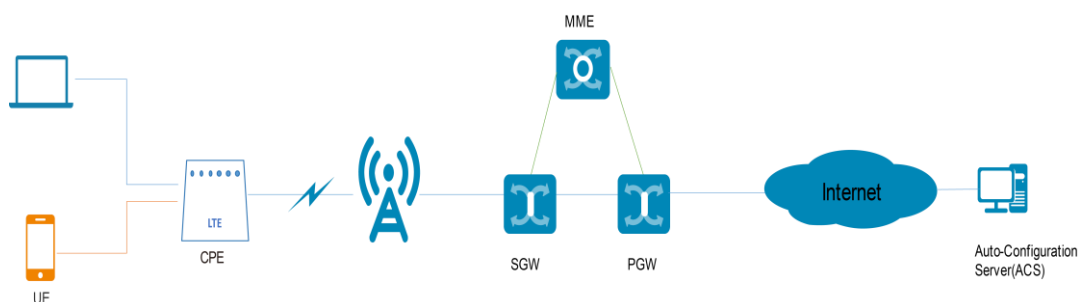

## 3.13 HOTA

The B818-263 supports the HOTA feature, which allows users to remotely update the device firmware through the HOTA server.

# 4 System Structure and Scenario Constraints

## 4.1 System Architecture

Figure 4-1 System structure

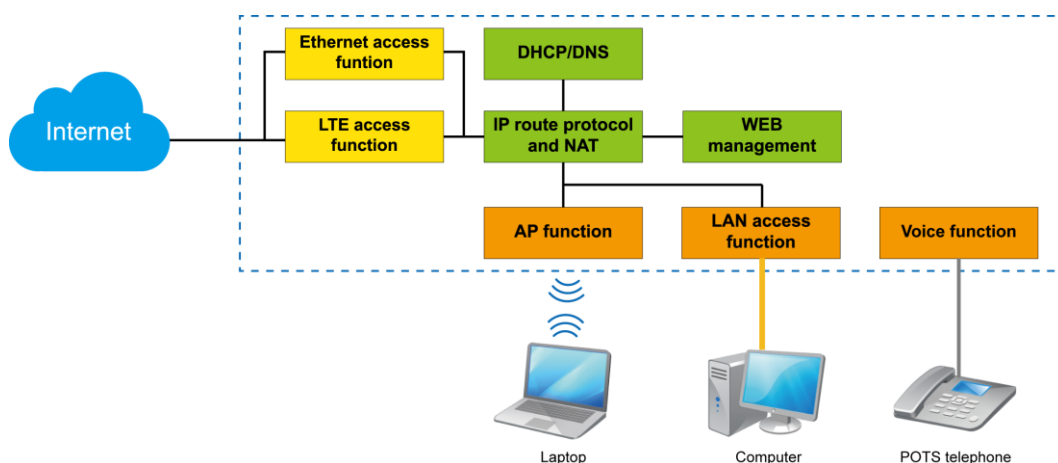

The following describes the modules shown in Figure 4-1.

- LTE access function: The B818-263 adopts the LTE access technology at the WAN side.
- LAN access function: One 10/100/1000 Mbps high-speed Ethernet ports are provided at the LAN side. The B818-263 provides the switching function for local networking and sharing of the broadband network when it is connected to terminal devices.
- AP function: An 802.11b/g/n/a/ac-compliant Wi-Fi AP interface is provided for wireless networking at home. The interface is compliant with the IEEE 802.11b/g/n/a/ac standard and the WEP, WPA/WPA2-PSK, WPA2-PSK security authentication mechanisms.
- DHCP/DNS: The DHCP server dynamically allocates IP addresses to PCs.
- Web-based management: You can configure the B818-263 and modify and view the configuration of the B818-263.
- IP routing protocol and NAT: The B818-263 has high-speed routing capability. With the built-in NAT, the B818-263, together with LTE terminals, can provide flexible broadband access solutions and networking schemes.

- Voice function: The B818-263 supports voice services.

## 4.2 Scenario Constraints

The B818-263 is a household wireless broadband access product designed for use in scenarios with relatively few network access devices and relatively low network reliability requirements, such as homes or small office and home offices (SOHOs).

The B818-263 is not an enterprise-grade product. It cannot be used by medium- or large-sized enterprises or in scenarios with high network reliability requirements, such as banks, securities agencies, traffic control, and communications device backhaul.

The B818-263 has the following constraints:

- When the IP Pass-Through mode is enabled, the HOTA function cannot be used.
- When the L2TP/PPTP VPN client function is enabled, the throughput performance will slow down.
- A maximum of 64 devices can be connected to the Wi-Fi in theory; the actual number of devices that can be connected and served depends on actual conditions.



# 5 Technical References

## 5.1 Standards and Communication Protocols

### 5.1.1 Standards and Communication Protocols of the Product

**Table 5-1** Standards and communication protocols of the product

Item	Description
Physical layer	RFC894
ARP	RFC826
IP	RFC791, RFC1122, RFC1071, RFC1141, RFC1624, RFC792, RFC950, RFC1256
ICMP	RFC792, RFC950, RFC1256
TCP	RFC793
UDP	RFC768
DHCP	RFC1531, RFC1533
NAT	RFC1631, RFC2663, RFC3022, RFC3027
VoIP	RFC3261,RFC2327,RFC1889,RFC1890,RFC3550

### 5.1.2 Standards and Communication Protocols of the Wireless Uu Interface

This device supports 3GPP Release 13.

# 6 Packing List

**Table 6-1** Packing list

Description	Quantity	Remarks
Wireless Gateway	1	Standard
Power supply adapter	1	Standard
Quick Start	1	Standard
Ethernet cable	1	Optional
Warranty card	1	Optional
Phone cable	1	Optional

The HUAWEI B818-263 wireless gateway has an optional external antenna.